

# CC484/CC486/CC488



Security Systems

EN

Operators Manual  
Solution Ultima Series  
(844/862/880)

**BOSCH**

## Copyright Notice

Unless otherwise indicated, this publication is the copyright of Bosch Security Systems Pty Ltd (“**Bosch**”). All rights are reserved.

You may download a single copy of this publication. By downloading the publication you agree that you will: (i) only use the publication for your own reference; (ii) not commercially exploit or charge any person for the use of the publication; and (iii) not modify the publication in any way without the prior written permission of Bosch.

Except as specified above or where authorised by the Copyright Act 1968 (Cth), no part of this publication may be reproduced, transmitted, modified or stored, in any form or by any means, without the prior written permission of Bosch.

## Notice of Liability

This material is designed for use by tradespeople with expertise in the installation of this product. Persons without appropriate expertise should seek assistance before attempting installation.

While care has been taken in the preparation of this material, Bosch Security Systems Pty Ltd and its representatives will not be responsible to any person or entity for any loss or damage directly or indirectly caused by information in, or any omission from, this material.

Bosch Security Systems Pty Ltd reserves the right to make changes to features and specifications of its products at any time without prior notification.

## New Zealand Telepermit Notes

The grant of a telepermit for a device in no way indicates Telecom acceptance of responsibility for the correct operation of that device under all operating conditions.

This equipment will not be used in any manner that could constitute a nuisance to other telecom customers.

Immediately disconnect this equipment should it become physically damaged and arrange for its disposal or repair.

The transmit level from this device is set at a fixed level and because of this, there may be circumstances where the performance is less than optimal. Before reporting such occurrences as faults, please check the line with a standard telepermitted telephone and do not report a fault if the telephone performance is satisfactory.

This device is equipped with pulse dialling while the Telecom standard is DTMF tone dialling. There is no guarantee that Telecom lines will always continue to support pulse dialling.

Use of dialling, when this equipment is connected to the same line as other equipment, may give rise to bell noise and also cause a false answer condition. Should such problems occur, the user should **not** contact the Telecom Faults Service.

This equipment is set up to carry out test calls at pre-determined times. Such test calls can interrupt any other calls that may be set up on the line at the same time. The timing set for such test calls should be discussed with the installer.

The timing set for test calls from this equipment may be subject to drift. If this proves to be inconvenient and your calls are interrupted, then the problem of timing should be discussed with the equipment installer. The matter should **not** be reported as a fault to Telecom Faults Service.

This equipment shall not be set up to make automatic calls to the Telecom 111 Emergency Service.

This equipment should not be used under any circumstances that may constitute a nuisance to other Telecom customers.

In the event of any problem with this device, the systems battery, AC mains supply, and telephone line should be disconnected. The user is to arrange with the supplier of the device to make the necessary repairs.

Should the matter be reported to Telecom as a wiring fault and the fault proven to be due to this product, a call-out charge will be incurred.

# Table of Contents

1.	Introduction .....	5	14.1	Horn Speaker Test.....	14
2.	Specifications .....	5	14.2	Bell Test .....	14
3.	Codepad Indicators.....	5	14.3	Strobe Test.....	14
3.1	Zone Indicators.....	6	14.4	Walk Test Mode.....	14
3.2	AWAY Indicator .....	6	14.5	Test Report .....	15
3.3	STAY Indicator .....	6	15.	Event Memory .....	15
3.4	System Disarmed.....	6	16.	Day Alarm .....	15
3.5	MAINS Indicator .....	6	17.	Codepad Buzzer Tone Change .....	15
3.6	Off Indicator/Zone Sealed .....	6	18.	Remote Arming by Telephone.....	15
3.7	On Indicator/Zone In Alarm.....	6	19.	Partitioning .....	15
3.8	FAULT Indicator .....	7	19.1	Master Partitioned Codepad Indicators.....	16
3.9	Audible Indications.....	7	19.1.1	Zone Indicators .....	16
3.10	Arming the System.....	7	19.1.2	Area On/Off Indicators.....	16
3.10.1	Forced Arming .....	7	19.1.3	Area Display Indicators.....	16
3.10.2	Arming in AWAY Mode.....	7	19.1.4	Status Indicators	16
3.10.3	Arming in STAY Mode 1.....	8	19.2	Operation of Codepads in Partitioning .....	16
3.10.4	Arming in STAY Mode 2.....	8	20.	Domestic Dialling .....	16
3.10.5	Programming STAY Mode 2 Zones .....	9	20.1	Acknowledging Domestic Calls.....	16
4.	Disarming the System.....	9	20.2	Programming Domestic Telephone Numbers	17
5.	User Codes.....	9	20.3	Disable Domestic Dialling .....	17
5.1	Adding User Codes.....	9	21.	Basic Pager Reporting .....	17
5.2	Adding Radio Remote User Codes.....	9	21.1	Basic Pager Display Information .....	17
5.3	Deleting User/Radio Codes .....	9	22.	Glossary of Terms.....	20
6.	Radio Transmitter Operations.....	10	23.	Installation Notes .....	22
7.	Codepad Alarms .....	10	<b>Figures</b>		
7.1	Codepad Duress Alarm .....	10	Figure 1:	CP5 Eight Zone LED Codepad.....	5
7.2	Codepad Panic Alarm .....	10	Figure 2:	CP5 Eight Zone LCD Codepad .....	5
7.3	Codepad Fire Alarm .....	10	Figure 3:	RF3332 – Two Button RF Keyfob .....	10
7.4	Codepad Medical Alarm .....	10	Figure 4:	RF3334 – Four Button RF Keyfob.....	10
7.5	Codepad Tamper Alarm (Access Denied) ..	11	Figure 5:	CP5 LED Codepad Showing Audible Alarm Buttons .....	10
8.	Isolating Zones.....	11	Figure 6:	Master Partitioned Codepad.....	16
8.1	Standard Isolating .....	11	Figure 7:	Basic Pager Display .....	19
8.2	Code to Isolate .....	11	<b>Tables</b>		
9.	Fault Analysis Mode .....	11	Table 1:	Specifications .....	5
9.1	Fault Descriptions.....	12	Table 2:	Zone Indicators .....	6
10.	Date and Time.....	13	Table 3:	AWAY Indicator.....	6
11.	Turning Outputs On/Off.....	13	Table 4:	STAY Indicator.....	6
12.	Reset Latching Outputs .....	13	Table 5:	MAINS Indicator .....	6
13.	Telco Arm/Disarm Sequence (Call Forward On/Off) .....	13	Table 6:	FAULT Indicator .....	7
13.1	Telco Arm Sequence.....	13	Table 7:	Audible Indicators .....	7
13.2	Telco Disarm Sequence.....	14	Table 8:	Arming Methods.....	7
14.	Testing.....	14	Table 9:	How to Arm the System in AWAY Mode .....	8

Table 10:	How to Arm the System in STAY Mode 1 .....	8
Table 11:	Fault Indicators.....	12
Table 12:	Telco Arm/Disarm Dialling Digits.....	14
Table 13:	Domestic Dialling Telephone Digits .....	17
Table 14:	Zone Status Display Descriptions.....	18
Table 15:	System Status .....	18
Table 16:	Glossary of Terms .....	20

## 1. Introduction

Congratulations on selecting the Solution Ultima Series Control Panel (models CC484/CC486/CC488) to protect you and your property. To obtain the most from your unit, take time to read through this manual and familiarise yourself with the numerous outstanding operating features of this system. In all aspects of planning, engineering, styling, operation, convenience, and adaptability, we have sought to anticipate your every possible requirement.

Programming simplicity and speed were some of the major considerations and we believe that our objectives in this area were more than satisfied.

This manual explains all aspects of operating the control panel. All system parameters and options are detailed; however, suitability is left up to the individual. Every system can be tailored to meet all requirements quickly and easily.

## 2. Specifications

**Table 1: Specifications**

<b>Temperature Range</b>	0°C to +45°C (+32°F to +113°F)
<b>Humidity</b>	10% to 95%
<b>Power Source</b>	TF008 Plug Pack – 240 V/18 VAC @ 1.3 A
<b>Stand-By Current</b>	65 mA
<b>Current Draw in Alarm Condition</b>	115 mA
<b>Current Draw in Alarm Condition with Codepad</b>	105 mA
<b>Back-Up Battery</b>	6 Ah/12 VDC Rechargeable Sealed Lead Acid Battery
<b>Dimensions (Case, packed in carton)</b>	306 mm x 262 mm x 84 mm (12.05 in. x 10.31 in. x 3.31 in.)
<b>Weight</b>	2.5 kg (5.51 lb.)
<b>Supplier Code</b>	N771
<b>New Zealand Telepermit</b>	Solution Ultima 844 – PTC 211/98/085 Solution Ultima 862 – PTC 211/98/084 Solution Ultima 880 – PTC 211/98/083
<b>Malaysia Approval Number</b>	Pending



The Austel permit issued for this product is subject to the following condition:  
The Solution Ultima Series Control Panel may only be powered by a Bosch Security Systems TF008 plug pack (Approval Number Q92128).



Test the sirens, strobe, and zones at weekly intervals. See *Section 14. Testing* for further information.

## 3. Codepad Indicators

**Figure 1: CP5 Eight Zone LED Codepad**

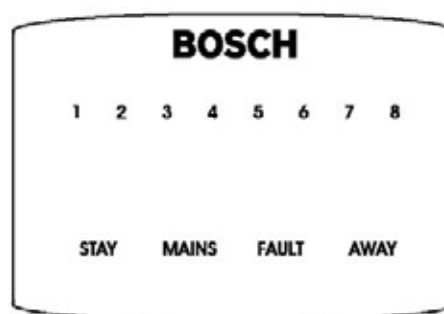

**Figure 2: CP5 Eight Zone LCD Codepad**

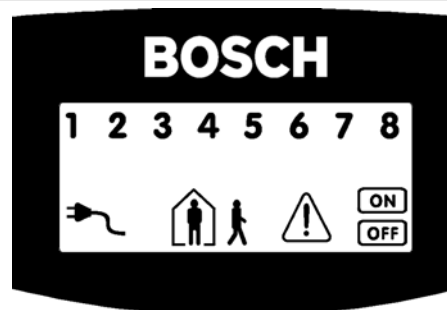

The codepad is the communications interface between you and your alarm system. Use the codepad to issue commands. The codepad offers both visual and audible indications that guide you through the general operation.

The codepad incorporates numerous indicators. There are zone indicators used to show the condition of each zone. Four other indicators show general status. The following pages outline a list of situations and the relevant indicators that are seen.

### 3.1 Zone Indicators

**1 2 3 ....** The zone indicators (1 to 8) display the status of the zones. *Table 2* lists the various circumstances that the indicators display (such as Zone Sealed, Zone Unsealed, and so on).

Indicator	Definition
On	Zone is unsealed.
Off	Zone is sealed.
Flashing Fast (0.25 seconds on/ 0.25 seconds off)	Zone is in alarm condition.
Flashing Slow (1 second on/ 1 second off)	Zone is manually isolated or selected to be isolated.

### 3.2 AWAY Indicator



The AWAY indicator displays that the system is armed in AWAY Mode. The AWAY indicator flashes in unison with the STAY indicator when programming various options throughout the *Operators Manual*. See *Section 3.10.2 Arming in AWAY Mode* for information on the different methods of arming the system in AWAY Mode.

Indicator	Definition
On	System is armed in AWAY Mode.
Off	System is not armed in AWAY Mode.

### 3.3 STAY Indicator



The STAY indicator displays that the system is armed in STAY Mode 1 or STAY Mode 2. The STAY indicator also flashes in unison with the AWAY indicator when programming various options throughout the *Operators Manual*. See *Section 3.10.3 Arming in STAY Mode 1* for different methods of arming in STAY Mode 1. See *Section 3.10.4 Arming in STAY Mode 2* for the method of arming in STAY Mode 2.

**Table 4: STAY Indicator**

Indicator	Definition
On	System is armed in STAY Mode 1 or STAY Mode 2.
Off	System is not armed in STAY Mode 1 or STAY Mode 2.
Flashing twice a second	Zone isolating mode or setting STAY Mode 2 zones.
Flashing once every 3 seconds	Day alarm status – day alarm turned on.

### 3.4 System Disarmed



This indicator displays with the **OFF** indicator when the system is disarmed.

### 3.5 MAINS Indicator



The MAINS indicator displays that the system's AC mains supply is normal or failed.

**Table 5: MAINS Indicator**

Indicator	Definition
On	AC mains power normal.
Flashing	AC mains supply has failed.

### 3.6 Off Indicator/Zone Sealed



The **OFF** indicator displays when the system is in the disarmed state and flashes when a zone becomes unsealed during the disarmed state. The indicator stops flashing when all zones are sealed.

### 3.7 On Indicator/Zone In Alarm



The **ON** indicator displays when the system is armed in AWAY Mode and flashes when an alarm occurs. The indicator resets once a valid user code is entered.

### 3.8 FAULT Indicator



The FAULT indicator displays that the system detected a system fault. See *Section 9. Fault Analysis Mode* for additional information on system faults. Every time a new system fault is detected (such as, FAULT indicator flashing), the codepad begins to beep once every minute. Pressing the [#] button once cancels the once a minute beep and acknowledges the fault (such as, FAULT indicator on steady).

**Table 6: FAULT Indicator**

Indicator	Definition
On	There is a system fault that needs to be rectified.
Off	The system is normal, there are no faults.
Flashing	There is a system fault that needs to be acknowledged.

### 3.9 Audible Indications

*Table 7* defines the audible indicators given out by the codepad buzzer.

**Table 7: Audible Indicators**

Audible Indicator	Definition
One short beep	A button was pressed on the codepad, or exit time ended when armed in STAY Mode 1 or STAY Mode 2.
Two short beeps	The system accepted your code.
Three short beeps	The requested function was executed.
One long beep	Indicates the end of exit time when armed in AWAY Mode, or the requested operation was denied or aborted.
One beep every second	Walk Test Mode is currently active or a warning before automatic arming takes place.
One short beep every minute	There is a system fault waiting to be acknowledged.

### 3.10 Arming the System

There are several ways to arm the system depending on whether you are:

- Leaving the premises and require all active zones to be in a ready state for an intruder.
- Remaining in the premises and only require part of the system to be in a ready state for an intruder.

If a zone is not sealed at the end of exit time, the zone is automatically isolated and constantly displayed on the remote codepad. The zone becomes an active part of the system when the zone is restored.

For example, if a window is left open after exit time expired, the window is not an active part of the system until the window is closed. Opening the window after exit time expired causes an alarm condition.

*Table 8* defines the different methods for arming the system.

**Table 8: Arming Methods**

Mode	Arming Method
AWAY Mode	Arms the entire system. See <i>Section 3.10.2 Arming in AWAY Mode</i> .
STAY Mode 1	Arms all zones except those programmed to be automatically isolated by the installer. See <i>Section 3.10.3 Arming in STAY Mode 1</i> .
STAY Mode 2	Arms all zones except those programmed to be automatically isolated by the Master Code holder. See <i>Section 3.10.4 Arming in STAY Mode 2</i> .

#### 3.10.1 Forced Arming

The feature of arming the system when a zone is not sealed is known as forced arming. If the system does not arm and a long beep is heard, forced arming is not permitted. If this is the case, you must ensure that all zones are sealed or manually isolated before you can arm the system. See *Section 8. Isolating Zones*.

#### 3.10.2 Arming in AWAY Mode

When you leave your premises and require all zones to be in a ready state to detect intrusion, arm the system in AWAY Mode.

There are two different methods for arming the system in AWAY Mode. Method one is standard and always operates. Method two is optional and can be disabled by your installer if you do not want to use single button arming.

**Table 9: How to Arm the System in AWAY Mode**

<b>Method One</b>	Enter your user code followed by the [#] button (for example, [2580#]). Two beeps sound and the AWAY indicator displays. Exit time starts counting.
<b>Method Two</b>	Hold down the [#] button until two beeps sound. The AWAY indicator displays and exit time starts counting.

### 3.10.3 Arming in STAY Mode 1

STAY Mode 1 is only used when the perimeter and unused areas of the premises need to be armed to detect an intruder from entering the premises. At the same time, you can move freely within an area that is automatically isolated.

Only your security company can program zones automatically isolated in STAY Mode 1.

There are two different methods for arming the system in STAY Mode 1. Method one is standard and always operates. Method two is optional and may be disabled by your installer if you do not want to use single button arming.

#### Entry Guard Timer for STAY Mode 1

When arming the system in STAY Mode 1, an optional entry timer called Entry Guard Timer for STAY Mode 1 is available. Use this entry timer to delay the sirens if a zone is not automatically isolated and triggered an alarm condition. Entry Guard Timer For STAY Mode 1 is the delay time used for all zones except 24-hour zones when the system is armed in STAY Mode 1 or STAY Mode 2.

If the Entry Guard Timer for STAY Mode 1 is programmed and a zone was not automatically isolated is triggered, the codepad beeps twice a second until the entry timer expires or the system is disarmed. If the alarm condition is not reset by entering your user code followed by the [#] button (such as, [2580#]) before the entry timer expires, the sirens activate into alarm. Only your installer can program this feature.

**Table 10: How to Arm the System in STAY Mode 1**

<b>Method One</b>	Enter your user code followed by the [*] button (for example, [2580*]). Two beeps sound and the STAY indicator displays. Exit time starts counting. Any zones programmed to be automatically isolated in STAY Mode 1 flash until exit time expires. At the end of exit time, all zones selected to be automatically isolated turn off and the codepad gives one short beep.
<b>Method Two</b>	Hold down the [*] button until two beeps sound. The STAY indicator displays and exit time starts counting. Any zones programmed to be automatically isolated in STAY Mode 1 flash until exit time expires. At the end of exit time, the zone indicators turn off and the codepad gives one short beep.

### 3.10.4 Arming in STAY Mode 2

STAY Mode 2 is only used when the perimeter and unused areas of the premise need to be armed to detect an intruder from entering the premise. At the same time, allowing you to move freely within an area that is automatically isolated. Any Master Code user can program zones to be automatically isolated in STAY Mode 2.

#### Entry Guard Timer for STAY Mode 2

When arming the system in STAY Mode 2, an optional entry timer called Entry Guard Timer for STAY Mode 2 is available. Use this entry timer to delay the sirens if a zone is not automatically isolated and triggered into alarm condition. Entry Guard Timer for STAY Mode 2 is the delay time used for all zones except 24-hour zones when the system is armed in STAY Mode 1 or STAY Mode 2.

If the Entry Guard Timer for STAY Mode 2 is programmed and a zone that was not automatically isolated triggers, the codepad beeps twice a second until the entry timer expires or the system is disarmed. If the alarm condition is not reset by entering your user code followed by the [#] button (for example, [2580#]) before the entry timer expires, the sirens activate into alarm. Only your installer can program this option.



## How to Arm the System in STAY Mode 2

Hold down the [0] button until two beeps sound. The STAY indicator displays and exit time starts counting.

Any zones programmed to be automatically isolated in STAY Mode 2 flash until exit time expires. At the end of exit time, all zones selected to be automatically isolated extinguish and the codepad emits one short beep.

### 3.10.5 Programming STAY Mode 2 Zones

Programming zones to be automatically isolated in STAY Mode 2 are only carried out if you have a Master Code.

#### How to Program STAY Mode 2 Zones

1. Enter your four character Master Code, followed by [4] and the [#] button (for example, [25804#]). Three beeps sound and the STAY indicator flashes.
2. Enter the zone number to be automatically isolated, followed by the [\*] button (for example, [1\*] = Zone 1, [2\*] = Zone 2). The selected zone flashes. If you make a mistake, enter the same zone number followed by the [#] button to clear the incorrect zone. To select additional zones to be automatically isolated in STAY Mode 2, repeat Step 2 as many times as required.
3. Press the [#] button to exit this mode when you finish selecting all zones to be automatically isolated in STAY Mode 2. Two beeps sound and the STAY and AWAY indicators turn off.

## 4. Disarming the System

When you enter the premises after the system is armed in AWAY mode, or if you armed the system in STAY Mode 1 or STAY Mode 2, you must disarm the system to disable detection devices that activate an alarm.

If there was an alarm condition prior to disarming the system, a flashing zone indicator displays, indicating a previous alarm on that zone.

### How to Disarm the System

Enter your user code followed by the [#] button (for example, [2580#]). Two beeps sound.

## 5. User Codes

### 5.1 Adding User Codes

Only the Master Code holder can add or change other system user codes, including the Master Code. Up to eight user codes can be programmed to operate the system.

### How to Add a User Code

1. Enter your four character Master Code, followed by [1] and the [#] button (for example, [25801#]).  
Three beeps are heard and the STAY and AWAY indicators flash.
2. Enter the User Code number (1 to 8), followed by the [#] button (for example, [2#] = User 2, [8#] = User 8). Two beeps are heard and the selected user number displays on the codepad indicators.
3. Enter the digits required for the new code followed by the [#] button (for example, for User Code 5768, enter [5768#]). Two beeps are heard and the STAY and AWAY indicators turn off.  
To add or change other User Codes, repeat this procedure as many times as required.

### 5.2 Adding Radio Remote User Codes

Only the Master Code holder can add or change other system user codes. Up to eight radio user codes (User Codes 9 to 16) can be programmed to operate the system.

#### How to Add a Radio Remote User Code

1. Enter your four character Master Code, followed by [1] and the [#] button (for example, [25801#]).  
Three beeps sound and the STAY and AWAY indicators flash.
2. Enter the radio remote user code number (9 to 16), followed by the [#] button (for example, [9#] = User 9, [16#] = User 16). Two beeps are heard and the selected user number displays on the codepad indicators.
3. Enter the nine digit ID number found on the back of the radio remote hand held transmitter, followed by the [#] button. Two beeps are heard and the STAY and AWAY indicators extinguish.  
To add or change other radio remote user codes, repeat this procedure as many times as required.

### 5.3 Deleting User/Radio Codes

Only the Master Code holder can delete other system user codes.

#### How to Delete a User Code

1. Enter your four character Master Code, followed by [1] and the [#] button (for example, [25801#]).  
Three beeps sound and the STAY and AWAY indicators flash.

2. Enter the user code number (1 to 16), followed by the [#] button (for example, [2#] = User 2, [16#] = User 16). Two beeps sound and the selected user number displays on the codepad indicators.
3. Press the [\*] button to delete the selected User Code.  
Two beeps are heard and the STAY and AWAY indicators turn off. To delete other User Codes, repeat this procedure as many times as required.

## 6. Radio Transmitter Operations

**Figure 3: RF3332/E – Two Button RF Keyfob**

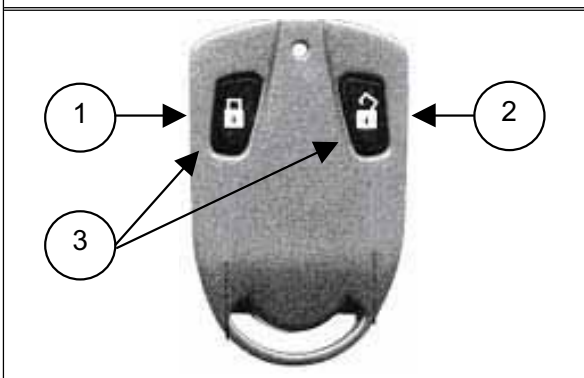

- 1 = Button 1: Arm in AWAY mode
- 2 = Button 2: Disarm from AWAY/STAY Mode
- 3 = Buttons 1 and 2: Press both buttons at same time to activate Panic alarm.

**Figure 4: RF3334/E – Four Button RF Keyfob**

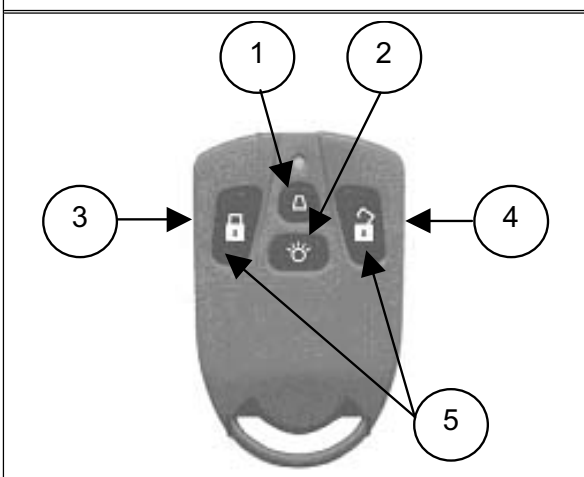

- 1 = Button 4: Arm in STAY Mode 1
- 2 = Button 3: Optional
- 3 = Button 1: Arm in AWAY mode
- 4 = Button 2: Disarm from AWAY/STAY Mode
- 5 = Buttons 1 and 2: Press both buttons at same time to activate Panic alarm.

## 7. Codepad Alarms

### 7.1 Codepad Duress Alarm

A codepad duress alarm is used as a silent hold-up alarm. This only occurs when the number 9 is added to the end of any valid user code being used to disarm the system (for example, [25809#]). A duress alarm is only useful if your system is reporting back to a monitoring station or pocket pager. Domestic reporting (such as a mobile phone) cannot decipher which type of alarm occurred.

**Figure 5: CP5 LED Codepad Showing Audible Alarm Buttons**

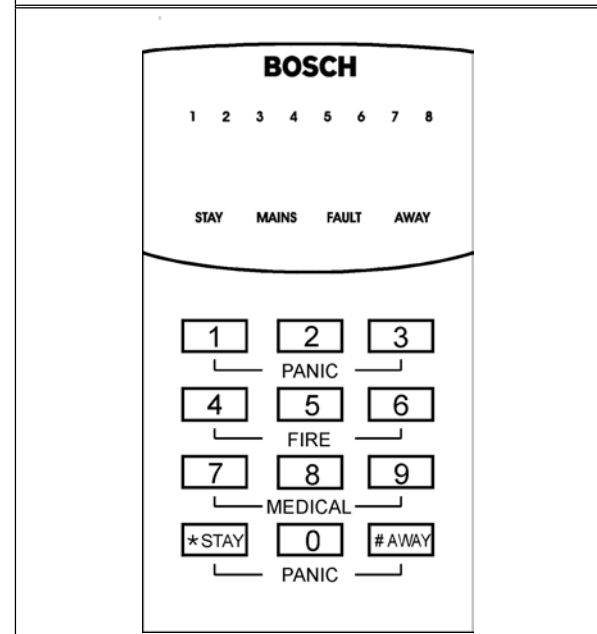

### 7.2 Codepad Panic Alarm

An audible alarm activates when both the [1] and [3] keys and both the [\*] and [#] keys are pressed simultaneously. Contact your installer to disable the codepad panic alarm function or to silence the codepad panic alarm.

### 7.3 Codepad Fire Alarm

The horn speaker emits a distinct fire sound when both the [4] and [6] keys are pressed simultaneously. Contact your installer to disable the codepad fire alarm function or to silence the codepad fire alarm.

### 7.4 Codepad Medical Alarm

An audible alarm activates when both the [7] and [9] keys are pressed simultaneously. Contact your installer to disable the codepad medical alarm function or to silence the codepad medical alarm.

## 7.5 Codepad Tamper Alarm (Access Denied)

Codepad tamper restricts the number of times an invalid user code can be used in an attempt to operate the system. When the number of incorrect code attempts equals the number programmed by your installer, the system activates an alarm condition. If reporting back to a security monitoring station, the system sends an Access Denied report.

To shutdown and lockout a codepad for a period of time (0 seconds to 150 seconds), ask your installer to program this function.

## 8. Isolating Zones

Use isolating zones to manually disable one or more zones before arming the system. Once a zone is isolated, you can access that zone during the armed state without activating an alarm.

For example, you need to isolate a zone because before arming the system a PIR detector may be false alarming, or you need to leave a pet inside a particular zone while away.

Isolating zones is performed by one of two methods. Method two is optional and only allows those user codes programmed by your installer to have access to isolate zones.

### 8.1 Standard Isolating

Standard isolating allows all operators to isolate zones without knowing a valid user code.

#### How to Isolate a Zone

1. Press the [\*] button twice to enter the Isolating Mode.  
Three beeps are heard and the STAY indicator flashes.
2. Enter the zone number (1 to 8), followed by the [\*] button (for example, [1\*] = Zone 1, [2\*] = Zone 2).  
Each zone to be isolated has a corresponding zone indicator that flashes. If you selected an incorrect zone to be isolated, enter the incorrect zone number again followed by the [\*] button.  
Repeat Step 2 if more than one zone is to be isolated until all zones to be isolated are selected.
3. Press the [#] button after all selected zones are isolated.  
Two beeps are heard and the system returns to the disarmed state.

## 8.2 Code to Isolate

This method restricts only those User Codes with the Code to Isolate priority level to isolate zones. If any User Code has this priority level, the method of standard isolating does not function.

#### How to Isolate a Zone

1. Press the [\*] button followed by your User Code and the [\*] button again to enter the Isolating Mode (for example, [\*2580\*]). Three beeps sound and the STAY indicator flashes.
2. Enter the zone number (1 to 8), followed by the [\*] button (for example, [1\*] = Zone 1, [2\*] = Zone 2).

Each zone to be isolated has a corresponding zone indicator that flashes. If you selected an incorrect zone to be isolated, enter the incorrect zone number again followed by the [\*] button.

Repeat Step 2 if more than one zone is to be isolated until all zones to be isolated are selected.

3. Press the [#] button after all selected zones are isolated.  
Two beeps sound and the system returns to the disarmed state.

## 9. Fault Analysis Mode

If a fault occurs, the FAULT or MAINS indicators flash and the codepad beeps once every minute.

If the AC mains supply fails, the MAINS indicator flashes until the AC mains supply is restored. Pressing the [#] button once acknowledges the fault and stops the codepad from beeping once every minute.

#### How to Determine the Type of System Fault

To determine which system fault occurred, enter Fault Analysis Mode by following the steps below:

1. Hold down the [5] key until two beeps sound.  
The FAULT indicator remains steady and the STAY and AWAY indicators flash in unison.  
A zone indicator displays the type of fault that occurred (for example, Zone 1 = System Fault). See *Table 11* for the list of possible system faults.
2. To further determine the type of fault condition, press and hold down the key that corresponds to the zone indicator displayed.  
For example, if Zone 1 displayed System Fault, press and hold the [1] key to display which system fault occurred.
3. To exit Fault Analysis Mode and return to the disarmed state, press the [#] key. The FAULT indicator continues to display and the codepad stops sounding once a minute.

Table 11: Fault Indicators

Zone Indicator	Fault Description	Hold Down Button	Zone Indicator	Fault Condition
1	System Fault	1	1	Battery Fail
			2	Date and Time
			3	RF Receiver Fail
			4	Horn Speaker Fail
			5	Telephone Line Fail
			6	E2 Fault
			7	Fuse Fail
			8	AC Fail
2	RF Low Battery	2	1 to 8	Zones 1 to 8 RF Low Battery
3	Zone Tamper Alarm	3	1 to 8	Zones 1 to 8 Tamper Alarm
4	Sensor Watch Fault	4	1 to 8	Zones 1 to 8 Sensor Watch Fail
5	RF Sensor Watch	5	1 to 8	Zones 1 to 8 RF Sensor Watch Fail
6	Communication Fail	6	1	Receiver 1 Fail
			2	Receiver 2 Fail

## 9.1 Fault Descriptions

### 1 System Fault

A system fault only displays when any of the following faults occur. After entering Fault Analysis Mode, press and hold the [1] key to determine which of the following faults occurred.

**Low Battery Fault** – A low battery fault registers when the system detects a low capacity back-up battery. The system automatically performs a battery test every four hours and every time you arm the system.

**Date and Time** – The date and time fault registers every time the system is powered down. This type of fault does not cause the FAULT indicator to display on the codepad unless your installer programmed the automatic arming time. See *Section 10. Date and Time* to program the date and time.

**RF Receiver Fail** – The RF receiver fault registers once the system detects that the wireless receiver unit is disconnected.

**Horn Speaker Fail** – This fault registers when the system detects that the horn speaker is disconnected. This fault clears once the horn speaker is reconnected. Your installer must program the system for this feature to operate.

**Telephone Line Fail** – A telephone line fault registers when the system detects that the telephone line is disconnected from the control panel. Your installer must program the system for this feature to operate.

**E2 Fault** – An E2 fault registers when the system detects an internal checksum error. Contact your installer as soon as this fault displays.

**Fuse Fail** – This fault occurs when either of the two 1 A fuses blow. Contact your installer as soon as this fault displays.

### 2 RF Low Battery

This fault occurs when any of the RF wireless devices report a low battery condition to the control panel. While in Fault Analysis Mode, press and hold the [2] key until two beeps sound. This displays the zone reporting the RF Low Battery fault.

### 3 Tamper Fail

This fault occurs when any zone becomes an open circuit. Press and hold the [3] key until two beeps sound. This displays the zone reporting the tamper fail fault.

#### 4 Sensor Watch Fault

A sensor watch fault registers because one or more detection devices failed to detect any movement during the disarmed state for the time period programmed by your installer. The fault clears once the zone in question detects movement and resets.

Press and hold the [4] key until two beeps sound. This displays the zone reporting the sensor watch fault.

#### 5 RF Sensor Watch

An RF sensor watch fault registers because one or more RF detection devices fails to communicate to the RF radio receiver for the time period programmed by your installer. The fault clears once the RF device in question successfully transmits to the RF radio receiver.

Press and hold the [5] key until two beeps sound. This displays the RF detection device reporting the RF sensor watch fault.

#### 6 Communication Fail

A communication fail registers when the control panel fails to communicate with the receiving party (such as a monitoring company, mobile phone, or pocket pager). The communication fault clears once the control panel successfully reports to the receiving party.

To determine which receiver failed to communicate, press and hold the [6] key.

## 10. Date and Time

Programming the date and time is only required when you need functions such as automatic test reports, automatic arming, and history events to operate correctly.

### How to Program the Date and Time

1. Enter your four character Master Code, followed by [6] and the [#] key (for example, [25806#]).  
Three beeps sound, and the STAY and AWAY indicators flash.
2. Enter the day, month, year, hour, and minute (DD, MM, YY, HH, MM format) (for example, DD = day of the month, MM = month of the year, YY = current year, HH = hour of the day, MM = minute of the day).  
To program the hour of the day, use the 24:00 hour format.

3. Press the [#] button to exit and return to the disarmed state.  
Two beeps sound, and the STAY and AWAY indicators turn off. If a long beep sounds, an error was made when entering the date and time.

## 11. Turning Outputs On/Off

This feature is only applicable if your installer set up an output that can be turned on or off by the codepad. The output programmed by your installer can control a pool pump or outside lighting. Up to three separate outputs can be programmed.

### How to Turn an Output On or Off

1. Enter your four character Master Code, followed by [5] and the [#] key (for example, [25805#]).  
Three beeps sound and the STAY and AWAY indicators flash.
2. Enter the output number (1 to 3).
3. Press the [#] key to turn the output on, or press the [\*] key to turn the output off.  
Three beeps sound if the output is turned on, and two beeps sound if the output is turned off.  
Repeat Step 2 and Step 3 if more than one output is required to be turned on or off.
4. Press the [#] key to exit this function.  
Two beeps sound and the STAY and AWAY indicators turn off.

## 12. Reset Latching Outputs

This feature is only applicable if your installer programmed an output to latch (remain on) until you acknowledge the event that occurred.

### How to Reset Latching Outputs

Hold down the [7] key until two beeps sound. The output resets.

## 13. Telco Arm/Disarm Sequence (Call Forward On/Off)

Use this feature to program the Telco Arm Sequence and Telco Disarm Sequence.

### 13.1 Telco Arm Sequence

Use to program the Call Forward – Immediate On sequence or Call Forward – No Answer sequence to automatically operate when you arm the system in the AWAY Mode. This feature is only available if your telecommunications provider has the call-forward option available.



The examples given in this feature are only applicable to Australia.

### Call Forward – Immediate On

You can redirect calls to anywhere in Australia, including mobile phones, pagers, and answering services. When Call Forward is turned on, your telephone does not ring.

### Call Forward – No Answer

When your telephone is not answered within 20 seconds, this feature redirects all incoming calls to another number anywhere in Australia. You can still make outgoing calls.

### How to Program the Telco Arm Sequence

1. Enter your four character Master Code, followed by the [3] and [#] keys (for example, [25803#]).  
Three beeps sound and the STAY and AWAY indicators flash.
2. Press the [1] key followed by the [#] key to select the Telco Arm Sequence. Three beeps sound.
3. Enter the Call Forward Sequence (for example, [\*61][Phone Number][#] to program the Call Forward - No Answer Sequence or [\*21][Phone Number][#] to program the Call Forward Immediate Sequence).  
To program an "\*" in the Telco Arm Sequence, enter [\*1], and to program a "#" in the Telco Arm Sequence, enter [\*2].
4. Press the [#] key when finished.  
Two beeps sound, and the STAY and AWAY indicators turn off.



To disable the Telco Arm Sequence, enter the Call Forward Sequence as [\*4] (break) for Step 3.

### 13.2 Telco Disarm Sequence

Use this function to automatically disable the call forward sequence upon disarming the system.

#### How to Program the Telco Disarm Sequence

1. Enter your four-character Master Code, followed by the [3] and [#] keys (for example, [25803#]).  
Three beeps sound, and the STAY and AWAY indicators flash.
2. Press the [2] key followed by the [#] key to select the Telco Disarm Sequence. Three beeps sound.
3. Enter the Call Forward Disable Sequence (for example, [#61#] to disable the No Answer Call Forward sequence, or [#21#] to disable the Call Forward Immediate Sequence).



To program a "#" in the Telco Disarm Sequence, enter [\*2].

4. Press the [#] key when finished.  
Two beeps sound, and the STAY and AWAY indicators turn off.



To disable the Telco Disarm Sequence, enter the Call Forward Sequence as [\*4] (break) for Step 3.

**Table 12: Telco Arm/Disarm Dialling Digits**

Digit Required	Number to Program	Digit Required	Number to Program
0	0	8	8
1	1	9	9
2	2		
3	3	*	*1
4	4	#	*2
5	5	4-second Pause	*3
6	6	Break	*4
7	7		

## 14. Testing

The following functions let you confirm that your system is operating correctly:

### 14.1 Horn Speaker Test

Hold the [1] key until two beeps sound. The horn speaker sounds for 2 seconds.

### 14.2 Bell Test

Hold the [2] key until two beeps sound. The bell output operates for 2 seconds.

### 14.3 Strobe Test

1. Hold the [3] key until three beeps sound.  
The strobe flashes.
2. Hold the [3] key until two beeps sound.  
The strobe stops flashing.

### 14.4 Walk Test Mode

Use Walk Test Mode to test detection devices to ensure that they are operating correctly. Every time you test a zone, the codepad sounds one long beep, and the horn speaker sounds one short beep to indicate that the zone is activated when testing.

1. Enter your four character Master Code, followed by the [7] and [#] keys (for example, [25807#]).  
Three beeps sound, and the STAY and AWAY indicators flash. The codepad beeps once every second while the system is in Walk Test Mode.

2. Activate all zones requiring the test.
3. When you finish testing all required zones, press the [#] key to exit this mode. Two beeps sound, and the STAY and AWAY indicators turn off. The system returns to the disarmed state.

### 14.5 Test Report

This feature only applies if your system reports using the telephone. By holding down the [9] key until two beeps sound, the system sends a Test Report.

## 15. Event Memory

Use this function to replay the last 40 events that the system recorded. The event memory history replays all alarms and the arming/disarming of the system in AWAY Mode, STAY Mode 1, and STAY Mode 2. However, the system cannot differentiate between arming the system in STAY Mode 1 or STAY Mode 2.

### How to Enter Event Memory

Enter your four-character Master Code, followed by [8] and the [#] button (for example, [25808#]). Three beeps sound. The last 40 events display one at a time by the codepad indicators, starting with the most recent event. A beep sounds as each event displays.

## 16. Day Alarm

Day alarm monitors a combination of zones during the disarmed state. It beeps the codepad buzzer if activated. Only your installer can program zones 1 to 4 to operate for day alarm.

### Example

A day alarm can be configured for the front door of a shop with a pressure mat or electronic beam that customers activate as they enter the shop. When customers step on the pressure mat or break the electronic beam, the codepad buzzer beeps.

### How to Turn Day Alarm On

Hold down the [4] key until three beeps sound. Day alarm turns on. All zones programmed for day alarm operation cause the codepad buzzer to beep during the disarmed state when activated.

### How to Turn Day Alarm Off

Hold down the [4] key until two beeps sound. Day alarm turns off.

## 17. Codepad Buzzer Tone Change

Hold down the [8] key to continuously change the tone of the codepad buzzer. There are 50 different tones, from 1500 Hz to 5000 Hz. If multiple codepads are installed, each codepad can have a different tone.

## 18. Remote Arming by Telephone

Arm your system from any remote location using the telephone. For security reasons, the system cannot be disarmed using this method. This feature requires a touch-tone telephone. Your installer must program this feature to operate.

### How to Remotely Arm Your System by Telephone

1. Call the telephone number connected to your control panel.
2. When the control panel answers the incoming call, a short jingle sounds. To arm the system, press the [\*] key on the touch-tone telephone for 1 second to 3 seconds.  
If you hear modem tones when the control panel answers the incoming call, the system was programmed for remote programming functions by your installer. Wait for a pause between the tones before pressing the [\*] key. After releasing the [\*] key on the touch-tone telephone, two beeps sound, indicating that the system is armed in AWAY Mode.
3. Hang up the telephone and the system remains armed.



If your installer programmed answering machine bypass, call the control panel twice to make a connection with the system. For example, call the telephone number your control panel is connected to and let the call ring no more than four times. Hang up the telephone. Wait a minimum of 8 seconds before you calling the control panel again.

## 19. Partitioning

This feature only applies to the Solution Ultima 880 Control Panels. Your control panel can be partitioned into four individual areas. Each area can be operated from one Master Partitioned codepad, or from separate Area Addressable codepads.

## 19.1 Master Partitioned Codepad Indicators

The indicators on a Master Partitioned codepad are configured into four groups (such as Zone Indicators, Area On/Off Display, Area Display, and Status Indicators). See *Figure 6*.

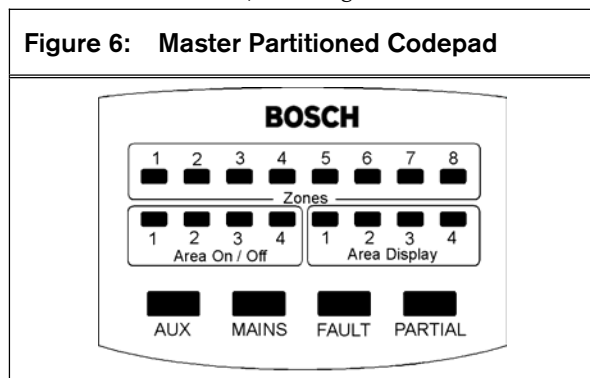

### 19.1.1 Zone Indicators

Zone indicators 1 to 8 show the status of each zone. These zones belong to the area that has the Area Display indicator lit. For example, if an indicator is lit, that zone is unsealed. If the indicator is dark, that zone is sealed.

### 19.1.2 Area On/Off Indicators

The group of four Area On/Off indicators display the status of each area. For example, if an indicator is lit, that area is armed. If the indicator is dark, that area is disarmed.



Only Area 1 and Area 2 can be used with the Solution Ultima 880 Control Panel.

### 19.1.3 Area Display Indicators

The group of four AREA DISPLAY indicators show which area the zones displayed belong to.

### 19.1.4 Status Indicators

A group of four indicators display the following:

#### AUX Indicator

Displays when the control panel is using the telephone line communicating to the receiving party.

#### MAINS Indicator

Displays the status of the AC mains power. (For example, if the indicator is illuminated, the AC mains power supply is normal. If the indicator is flashing, the AC mains power supply is disconnected or failed.)

#### FAULT Indicator

Displays the status of the fault register. (For example, if the FAULT indicator is flashing, the system detected a fault that is not yet acknowledged. If the FAULT indicator is illuminated, the fault is acknowledged. If the FAULT indicator is not illuminated, the system has no faults.)

#### PARTIAL Indicator

Only displays when an area is armed in STAY Mode 1. (For example, if the PARTIAL indicator is displayed, an area is armed in STAY Mode 1. If the PARTIAL indicator is not displayed, no areas are armed in STAY Mode 1.)

## 19.2 Operation of Codepads in Partitioning

### Area Addressable Codepad Operations

If you have a system partitioned with Area Addressable eight-zone codepads, the operating procedure is the same as described for a non-partitioned system, except that all operations only relate to the area the codepad is assigned to.

### Master Partitioned Codepad Operations

If your system is partitioned with a Master Partitioned codepad installed, the operating procedure is the same as described for a non-partitioned system, except that all operations relate to the area displayed by the Area Display indicator.

#### Example

If the Area Display indicator displays number 2, all operations performed only operate in Area 2. To operate Area 1, you must toggle the Area Display indicator to number 1 by pressing the [#] key. Pressing the [#] key again toggles you back to the Area 2 display.

## 20. Domestic Dialling

Use domestic dialling can be used to call your mobile phone or a relative/friend if your control panel activates an alarm. Up to three different telephone numbers can be programmed for the control panel to call when an alarm occurs. Only your installer can program the system to report in the domestic format. The Master Code holder can change the telephone numbers at any time.

### 20.1 Acknowledging Domestic Calls

When an alarm condition occurs, the system calls the first programmed telephone number. When you answer an incoming call, the system repeatedly emits a siren tone followed by a pause, continuously for 2 minutes (for example, siren tone, pause, siren tone, and pause).



If you do not acknowledge the call from the control panel during a pause between siren tones, the control panel hangs up after 2 minutes and calls the next telephone number.

Pressing the [\*] key for 1 second to 3 seconds during the pause acknowledges the call. No further calls are made for that event. If the call was successfully acknowledged, a tone of decreasing pitch sounds.

**Table 13: Domestic Dialling Telephone Digits**

Digit Required	Number to Program	Digit Required	Number to Program
0	0	8	8
1	1	9	9
2	2		
3	3	*	*1
4	4	#	*2
5	5	4-second Pause	*3
6	6	Break	*4
7	7		

## 20.2 Programming Domestic Telephone Numbers

If your system is set up for domestic dialling, any Master Code holder can program telephone numbers that the control panel calls in the event of an alarm.

### How to Program Telephone Numbers

1. Enter your four character Master Code, followed by the [2] and [#] keys (for example, [25802#]).  
Three beeps sound and the STAY and AWAY indicators flash.  
If there are telephone numbers already programmed, they display one digit at a time by the codepad indicators.  
If there are no telephone numbers programmed, two more beeps sound after entering this mode. These two beeps normally sound after the last digit of the last telephone number displays.
2. Enter all digits for the first telephone number (for example, [96721717]).  
As each digit is entered, the corresponding codepad indicators display.
3. If there is more than one telephone number to program, press [\*4]. This inserts a break between the first telephone number and the second telephone number. If there is only one telephone number to program, press the [#] key to exit this function.

4. Enter all the digits of the second telephone number (for example, [96721055]).  
As each digit is entered, the corresponding codepad indicators display.
5. After the last digit of the second telephone number is programmed, press the [#] key to exit this function unless a third telephone number is required. If there is a third telephone number to program, press the [\*4] button to insert a break between the second telephone number and the third telephone number.

## 20.3 Disable Domestic Dialling

To cancel domestic dialling (for example, you are moving and do not want the system to continue calling your mobile phone), enter the following sequence.

1. Enter your four character Master Code, followed by the [2] and [#] keys (for example, [25802#]).  
Two beeps sound and the STAY and AWAY indicators flash.
2. Press the [\*] key followed by the [4] and [#] keys (for example, [\*4#]).  
The STAY and AWAY indicators are disabled.

# 21. Basic Pager Reporting

This feature only applies if your system reports to a pocket pager. Basic pager reporting requires some interpretation of the numbers appearing on the display. It is possible to differentiate between 1000 different systems when a number of control panels report to one pocket pager.

## 21.1 Basic Pager Display Information

### Subscriber ID Number

This is the identification number of the control panel, which can only be programmed by your installer.

### Zone Status

The zone status display shows the status of each zone (1 to 8). *Table 14* describes the meaning of each number when it appears on the zone status display.

**Table 14: Zone Status Display Descriptions**

Number Displayed	Zone Description
0	<b>Zone Normal</b> Indicates the corresponding zone is in the sealed state.
1	<b>Alarm</b> Indicates the corresponding zone is unsealed and in alarm condition.
2	<b>Zone Bypassed</b> Indicates a system operator manually isolated the corresponding zone. See <i>Section 8. Isolating Zones</i> for information on how to manually isolate a zone(s) prior to arming the system.
3	<b>Zone Trouble</b> Indicates a zone was left unsealed after the end of exit time.

**System Status**

The system status information is divided into four digits.

**Table 15: System Status**

System Status Display	Description
First digit	Indicates whether the system is armed or disarmed: 8 = Disarmed 9 = Armed
Second digit	Indicates which codepad alarm was triggered by the operator: 0 = No Codepad Alarm 1 = Codepad Panic or Duress Alarm 2 = Codepad Fire Alarm 3 = Codepad Medical Alarm
Third digit	Indicates when the AC mains supply fails: 0 = AC Supply is normal 1 = AC Supply has failed
Fourth digit	Indicates when a system fault occurs at the control panel: 0 = System Normal – There are no faults 1 = System Fault – There is a fault registered by the control panel

*Figure 7* shows that the transmission came from the control panel with ID number 678, and that zone 2 is in alarm. The figure also shows that zone 3 was manually isolated and the system armed.

**Figure 7: Basic Pager Display**

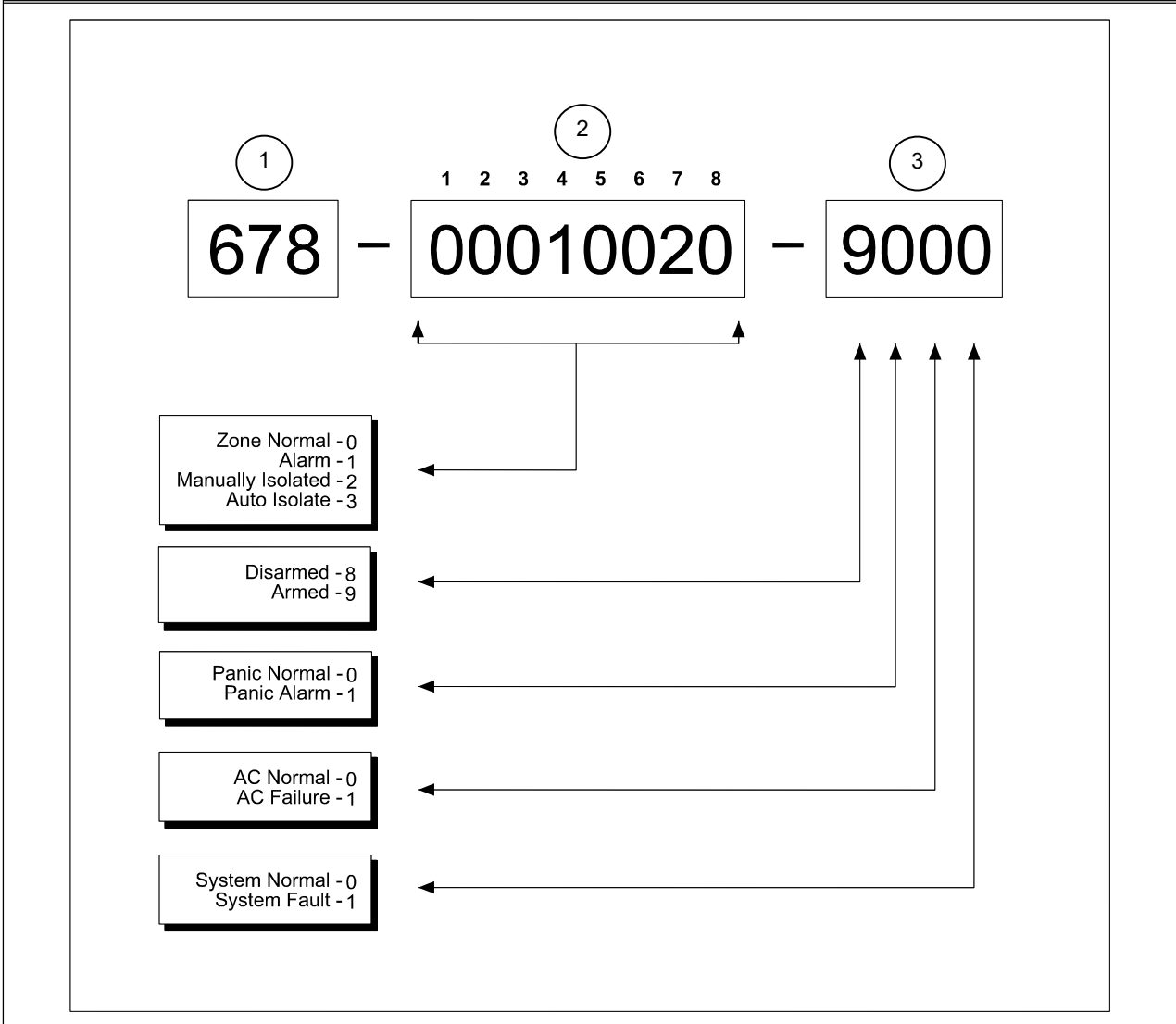

- 1 - Subscriber ID number
- 2 - Zone status
- 3 - System status

## 22. Glossary of Terms

**Table 16: Glossary of Terms**

Term	Description
Alarm Condition	Occurs when your alarm system is armed and one of the detection devices is violated. A 24-hour zone (such as a smoke detector) can activate an alarm condition when your system is armed or disarmed.
Answering Machine Bypass	Make a connection with the system for remote arming operations when there is an answering machine or facsimile machine on the same telephone line.
Area Codepad	Use if the system is partitioned into two separate areas. All operations at the area codepad do not affect the other area.
Armed	The system is ready to accept alarms.
Automatic Arming	Use to automatically arm the system at the same time every day in AWAY Mode or STAY Mode 1.
Automatic Disarming	Use to automatically disarm the system at the same time every day.
AWAY Mode	This is the mode used to arm your system when you leave your premises.
Codepad	Use to arm/disarm the system and carry out other functions such as adding and deleting system user codes.
Day Alarm	Monitor a combination of zones while the system is disarmed.
Detectors	Devices connected to your alarm system used to detect intrusion and cause an alarm condition. Some detection devices include, Passive Infrared (PIR), smoke detectors, photoelectric beams, reed switches, and vibration sensors.
Disarmed	A state in which your system does not accept alarms except on zones programmed for 24-hour operation.
Dynamic Battery Testing	Use to monitor and test the condition of your back-up battery.
Entry Time/ Entry Delay	Time allowed after entering your premises by a zone programmed for delayed operation so you can disarm the system.
External Equipment	Any device connected to your system, such as detectors, codepads, and sirens.
Forced Arming	Permits your alarm system to be armed when one or more zones are unsealed.
Handover Delay	Hands over the remaining delay time to a zone programmed as handover when your system is armed and a zone programmed for delay has been violated. The handover zone does not activate an alarm until the remaining delay time expires. A handover zone acts as an instant zone if violated before the delay zone.
Hand Held Remote Control	Use to remotely operate your system by hand held transmitters.
Isolating	Manually disable (isolate) one or more zones before arming the system.
Master Code	Numerical code used for arming and disarming the system, as well as allowing access to functions (such as adding and deleting user codes).
Master Partitioned Codepad	Used only if your system is partitioned (CC488 only). The codepad allows you to view and operate both areas from the same codepad.
Monitoring Station	Secure location where a digital receiver monitors numerous alarm systems and deciphers their Alarm Transmission Reports. The operator can then advise the appropriate authorities to take immediate action.
Panic Alarm	Indicates to the monitoring station there is an emergency situation at your premises.
Sealed	Refers to zone status. If a zone is sealed, the detection device is not violated and the zone indicator does not display on the codepad.

Table 16: continued

Term	Description
Sensor Watch	Use the control panel to recognise detection devices that have stopped working, or view a PIR detector that is blocked (unable to detect any movement over the duration of the time programmed by your installer).
Silent Alarm	Zones that your installer programs for silent operation. When the zone programmed for silent operation is violated during the armed period, your alarm system communicates with the monitoring station without sounding the sirens.
STAY Mode 1	Automatically isolates zones when your system is armed in STAY Mode 1. Only your installer can program zones to be isolated automatically in STAY Mode 1.
STAY Mode 2	Automatically isolates zones when your system is armed in STAY Mode 2. Only the Master Code holder can program zones to be isolated automatically in STAY Mode 2.
Telco Arm Sequence	Automatically calls the telephone exchange and diverts your telephone number to another telephone when the system is armed in AWAY mode. (In Australia, this feature is called Call Forward.)
Telco Disarm Sequence	Automatically calls the telephone exchange without forwarding your telephone number.
Unsealed	Refers to zone status. A zone is unsealed when a zone is violated. The corresponding zone indicator displays on the codepad.
User Code	Personal Identification Number (PIN) the operator uses to arm and disarm the system.
Zones	Monitored input used to trigger an alarm condition when violated.
24-Hour Zones	Monitored input programmed to trigger an alarm condition when violated when the system is armed or disarmed 24 hours a day.



### Zone Description

Allows you to describe each zone and mark whether the zone was programmed to be automatically isolated in STAY Mode 1, or was programmed for day alarm operation.

		Isolated In STAY Mode 1	Day Alarm Enabled
Zone 1	_____	<input type="checkbox"/>	<input type="checkbox"/>
Zone 2	_____	<input type="checkbox"/>	<input type="checkbox"/>
Zone 3	_____	<input type="checkbox"/>	<input type="checkbox"/>
Zone 4	_____	<input type="checkbox"/>	<input type="checkbox"/>
Zone 5	_____	<input type="checkbox"/>	
Zone 6	_____	<input type="checkbox"/>	
Zone 7	_____	<input type="checkbox"/>	
Zone 8	_____	<input type="checkbox"/>	

### User Code Names

		Master Code	
Default = 2580	User Code 1 _____	<input checked="" type="checkbox"/>	User Code 9 _____
	User Code 2 _____	<input type="checkbox"/>	User Code 10 _____
	User Code 3 _____	<input type="checkbox"/>	User Code 11 _____
	User Code 4 _____	<input type="checkbox"/>	User Code 12 _____
	User Code 5 _____	<input type="checkbox"/>	User Code 13 _____
	User Code 6 _____	<input type="checkbox"/>	User Code 14 _____
	User Code 7 _____	<input type="checkbox"/>	User Code 15 _____
	User Code 8 _____	<input type="checkbox"/>	User Code 16 _____

### Entry/Exit Times

Entry Timer 1 \_\_\_\_\_ Exit Time \_\_\_\_\_  
 Entry Timer 2 \_\_\_\_\_ Entry Guard Time \_\_\_\_\_

### Arming Options

Single Button Arming  YES  NO      Forced Arming  YES  NO  
 Single Button Disarming  YES  NO      Remote Arming by Telephone  YES  NO

Automatic Arming Time \_\_\_\_\_ AM/PM

Automatic Disarming Time \_\_\_\_\_ AM/PM

### Output Descriptions

Output 1 \_\_\_\_\_ Output 3 \_\_\_\_\_  
 Output 2 \_\_\_\_\_ Output 4 \_\_\_\_\_

### Isolating Method

Standard Isolating  YES  NO  
 Code to Isolate  YES  NO

### Communication Options

Back to Base Reporting  YES  NO  
 Domestic Reporting  YES  NO      Domestic Reporting – Number of Beeps

### Other System Information

Siren Run Time  Minutes

Can your system be serviced by another technician?  YES  NO      If Yes, Installer's Code \_\_\_\_\_



### 9 Digit RF User Code ID Numbers

Place the RF Radio Keyfob ID Sticker in the appropriate location below.

9	Radio User Code 9 ID Number	13	Radio User code 13 ID Number
10	Radio User code 10 ID Number	14	Radio User code 14 ID Number
11	Radio User code 11 ID Number	15	Radio User code 15 ID Number
12	Radio User code 12 ID Number	16	Radio User code 16 ID Number

### 9 Digit RF Device ID Numbers

Place the RF Device ID Sticker in the appropriate location below.

Zone Number		Zone Number	
1	RF Device 1 ID Number	9	RF Device 9 ID Number
2	RF Device 2 ID Number	10	RF Device 10 ID Number
3	RF Device 3 ID Number	11	RF Device 11 ID Number
4	RF Device 4 ID Number	12	RF Device 12 ID Number
5	RF Device 5 ID Number	13	RF Device 13 ID Number
6	RF Device 6 ID Number	14	RF Device 14 ID Number
7	RF Device 7 ID Number	15	RF Device 15 ID Number
8	RF Device 8 ID Number	16	RF Device 16 ID Number

24-Hour Zones .....20

**A**

Adding Radio User Codes ..... 8  
 Adding User Codes ..... 8  
 Advice To Users ..... 4  
 Alarm Condition..... 19  
 Answering Machine Bypass ..... 19  
 Area Addressable Codepad..... 16  
 Area Codepad..... 19  
 Area Display Indicator..... 15  
 Area On/Off Indicator..... 15  
 Armed..... 19  
 Arming  
     AWAY Mode..... 6  
     STAY Mode 1 ..... 7  
     STAY Mode 2 ..... 7  
     Telephone Arming ..... 15  
 Audible Indications ..... 6  
 Automatic Arming..... 19  
 Automatic Disarming ..... 19  
 AWAY Indicator ..... 5  
 AWAY Mode..... 6, 19

**B**

Battery Testing..... 19  
 Bell Test..... 14

**C**

Codepad ..... 4, 19  
     Buzzer Tone ..... 15  
     Duress Alarm ..... 10  
     Fire Alarm ..... 10  
     Medical Alarm ..... 10  
     Panic Alarm..... 10  
     Tamper Alarm..... 10  
 Codepad Indicators  
     Audible Indications ..... 6  
     AWAY Indicator ..... 5  
     FAULT Indicator ..... 6  
     MAINS Indicator..... 5  
     Off Indicator..... 5  
     On Indicator..... 5  
     STAY Indicator..... 5  
     System Disarmed ..... 5  
     Zone Indicators ..... 5  
 Communciation Fail..... 12

**D**

Date and Time ..... 12  
 Day Alarm ..... 14  
 Deleting Radio User Codes ..... 8  
 Deleting User Codes..... 8  
 Detectors ..... 19  
 Disarmed..... 19  
 Disarming ..... 8  
 Domestic Dialling ..... 16  
     Acknowledging Domestic Calls..... 16  
     Disable..... 17  
     Programming Domestic Telephone Numbers 16  
 Duress Alarm..... 10

**E**

E2 Fault..... 12  
 Entry Delay/Entry Time ..... 19  
 Entry Guard Timer ..... 7  
 Event Memory Recall ..... 14  
 External Equipment..... 19

**F**

Fault Analysis ..... 11  
 Fault Descriptions ..... 12  
     Communciation Fail ..... 12  
     Date and Time..... 12  
     E2 Fault ..... 12  
     Fuse Fail ..... 12  
     Horn Speaker ..... 12  
     Low Battery..... 12  
     RF Low Battery ..... 12  
     RF Receiver Fail..... 12  
     RF Sensor Watch ..... 12  
     Sensor Watch..... 12  
     System Fault..... 12  
     Tamper Fail ..... 12  
     Telephone Line Fail..... 12  
 FAULT Indicator ..... 6, 16  
 Fire Alarm..... 10  
 Forced Arming ..... 6, 19  
 Fuse Fail..... 12

**H**

Hand Held Remote Control..... 19  
 Handover Delay..... 19  
 Horn Speaker ..... 12  
 Horn Speaker Test..... 14

<b>I</b>	<b>S</b>
Installation Notes.....21	Sealed..... 19
Introduction .....4	Sensor Watch ..... 12, 20
Isolating .....19	Silent Alarm..... 20
Isolating Zones.....10	Specifications ..... 4
Code to Isolate.....10	STAY Indicator..... 5
Standard Isolating.....10	STAY Mode 1 ..... 7, 20
<b>L</b>	Entry Guard Timer ..... 7
LCD Codepad .....4	STAY Mode 2 ..... 7, 20
Low Battery .....12	Entry Guard Timer ..... 7
<b>M</b>	Programming Zones..... 7
MAINS Indicator..... 5, 16	Strobe Test..... 14
Master Code.....19	System Disarmed ..... 5
Master Partitioned Codepad .....19	<b>T</b>
Area Display Indicator .....15	Tamper Alarm..... 10
Area On/Off Indicator .....15	Tamper Fail ..... 12
FAULT Indicator .....16	Telco Arm Sequence ..... 13, 20
MAINS Indicator.....16	Telco Disarm Sequence..... 13, 20
Operating.....16	Telephone Line Fail..... 12
Partial Indicator .....16	Test Report..... 14
Zone Indicators .....15	Testing
Medical Alarm .....10	Bell Test..... 14
Monitoring Station .....19	Horn Speaker Test..... 14
<b>O</b>	Strobe Test..... 14
Off Indicator .....5	Test Report ..... 14
On Indicator .....5	Walk Test..... 14
Output	<b>U</b>
Reset Latching Outputs..... 13	Unsealed ..... 20
Turning On/Off.....13	User Codes ..... 20
<b>P</b>	Adding..... 8
Pager Reporting.....17	Adding Radio Users..... 8
Panic Alarm..... 10, 19	Deleting..... 8
Partial Indicator .....16	<b>W</b>
Partitioning	Walk Test..... 14
Area Addressable Codepad.....16	<b>Z</b>
Area Display Indicator .....15	Zone Indicators ..... 5, 15
Area On/Off Indicator .....15	Zones ..... 20
Codepad Operations .....16	
Zone Indicators .....15	
<b>R</b>	
Radio User Codes	
Adding .....8	
Deleting.....8	
Remote Arming .....15	
Remote Control.....19	
RF Low Battery.....12	
RF Receiver Fail.....12	
RF Sensor Watch.....12	

Bosch Security Systems  
25 Huntingwood Drive  
Huntingwood NSW 2148  
Australia  
Phone: +612 9672 1777  
Facsimile: +612 9672 7171

© 2003 Bosch Security Systems  
SUB-MA48XO-3318  
Issue 1.13  
4998152445B

**BOSCH**